

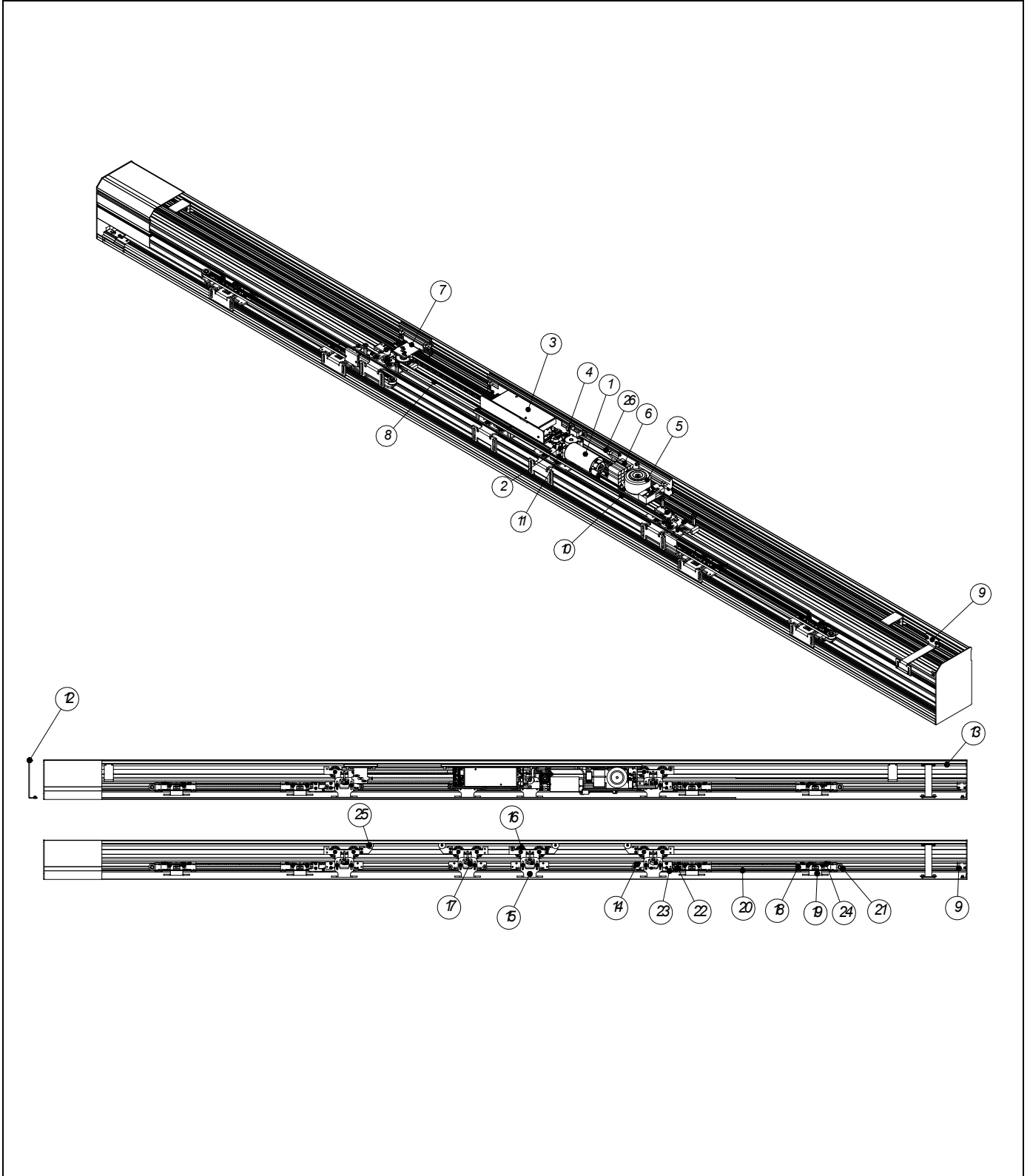

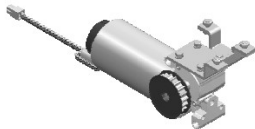







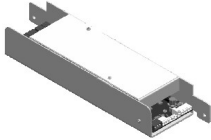

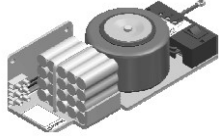

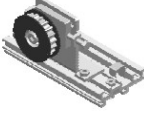

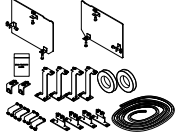
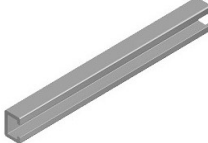

**OPERATORS T4**

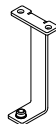



**OPERATORS T4**

Nº	Ilustración	Artículo	Código
1		GLOBAL 4 MOTOR SYSTEM	SUN41
2		GLOBAL 4 SYSTEM DRIVE PULLEY	SUN42
3		E4 / G4 / T4 MAIN BOARD	SER52
4		E4 / G4 / T4 POWER WIRE	SER54
5		E4/G4/T4 230V / 40V POWER SUPPLY UNIT E4/G4/T4 125V / 40V POWER SUPPLY UNIT	SER55 SER56
6		BATTERY PACK NI Cd	SER57
7		GLOBAL_4 BELT TIGHTER	SUN43
8		HTD 8M 10MM (8 METERS) BELT	SER59
9		TEL CLOSING	TEL CLOSING
10		ALUMINIUM ARM L=850MM ALUMINIUM ARM L=1050MM ALUMINIUM ARM L=500MM	SUN09 SUN10

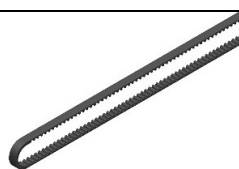
**OPERATORS T4**

11		GLOBAL/ERTAIN/TELESCOPIC'S ACCESSORIES BAG FOR THE BELT	SUN05
12		TELESCOPIC 4 CENTRAL COVER SUPPORT	SOPORTE TAPA TEL
13		ERTAIN_4 / GLOBAL 4 STOPPER	SER05
14		TELESCOPIC SYSTEM EXTERNAL CARRIER	STE02
15		TELESCOPIC SYSTEM EXTERNAL LEAF BRACKET	STE04
16		ERTAIN WHEEL <i>"Diámetro exterior = 52mm"</i>	SER16
17		ANTIDERRAILING WHEEL	SER17
18		TELESCOPIC SYSTEM INNER CARRIER	STE01
19		TELESCOPIC SYSTEM INNER LEAF BRACKET	STE03
20		HTD 5M 9 MM, -+0,5 BELT	STE05

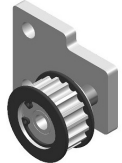

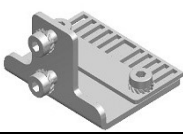
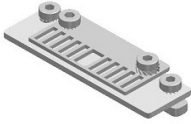
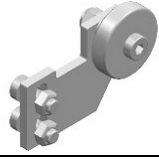
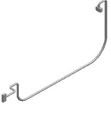
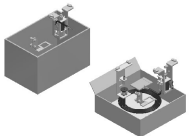
**OPERATORS T4**

21		TELESCOPIC SYSTEM FIXED PULLEY	STE06
22		TELESCOPIC SYSTEM MOBILE PULLEY	STE07
23		5M MOBILE FIXING STRAP	STE08
24		5M FIXED FIXING STRAP	STE09
25		ERTAIN SHAFT	ERTAIN CUERNO
26		E4 G4 T4 ENCODER CONEXIÓN WIRE	SER61
*		ELECTROLOCK FAILSAFE E4 G4 ELECTROLOCK FAILSECURE E4 G4	E4 FAILSAFE E4 FAILSECURE

---

**OPERATORS T4**

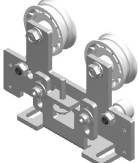
---

Nº	Ilustración	Artículo	Código
1		TELESCOPIC SYSTEM INS INSIDE CARRIER	STE01
2		TELESCOPIC SYSTEM OUTSIDE	STE02