

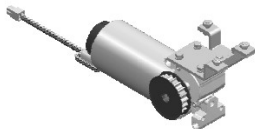









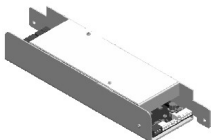

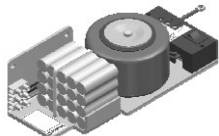

OPERATOR G4

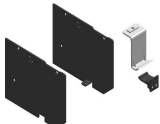
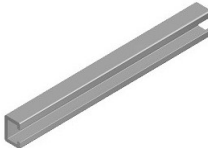
Nº	Ilustración	Artículo	Código
1		GLOBAL 4 MOTOR SYSTEM	SUN41
2		GLOBAL 4 SYSTEM DRIVE PULLEY	SUN42
3		E4 / G4 / T4 MAIN BOARD	SER52
4		E4 / G4 / T4 POWER WIRE	SER54
5		E4/G4/T4 230V / 40V POWER SUPPLY UNIT E4/G4/T4 125V / 40V POWER SUPPLY UNIT	SER55 SER56
6		BATTERY PACK NI Cd	SER57
7		GLOBAL_4 BELT TIGHTER	SUN43
8		HTD 8M 10MM (8 METERS) BELT	SER59
9		G2 CLOSING	G2 CLOSING
10		ALUMINIUM ARM L=850MM ALUMINIUM ARM L=1050MM ALUMINIUM ARM L=500MM	SUN09 SUN10

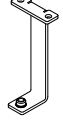
OPERATOR G4

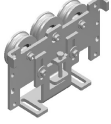
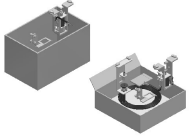
11		GLOBAL/ERTAIN/TELESCOPIC'S ACCESSORIES BAG FOR THE BELT	SUN05
12		GLOBAL 2 CENTRAL COVER SUPPORT	SOPORTE TAPA G2
13		ERTAIN_4 / GLOBAL 4 STOPPER	SER32
14		G2 / G3 / G4 CARRIER	SUN44
15		ERTAIN_2 / GLOBAL WHEEL <i>"Diámetro exterior = 51mm"</i>	SER34
16		E4 G4 ENCODER CONEXIÓN WIRE	SER61
17		ELECTROLOCK FAILSAFE E4 G4 ELECTROLOCK FAILSECURE E4 G4	E4 FAILSAFE E4 FAILSECURE