

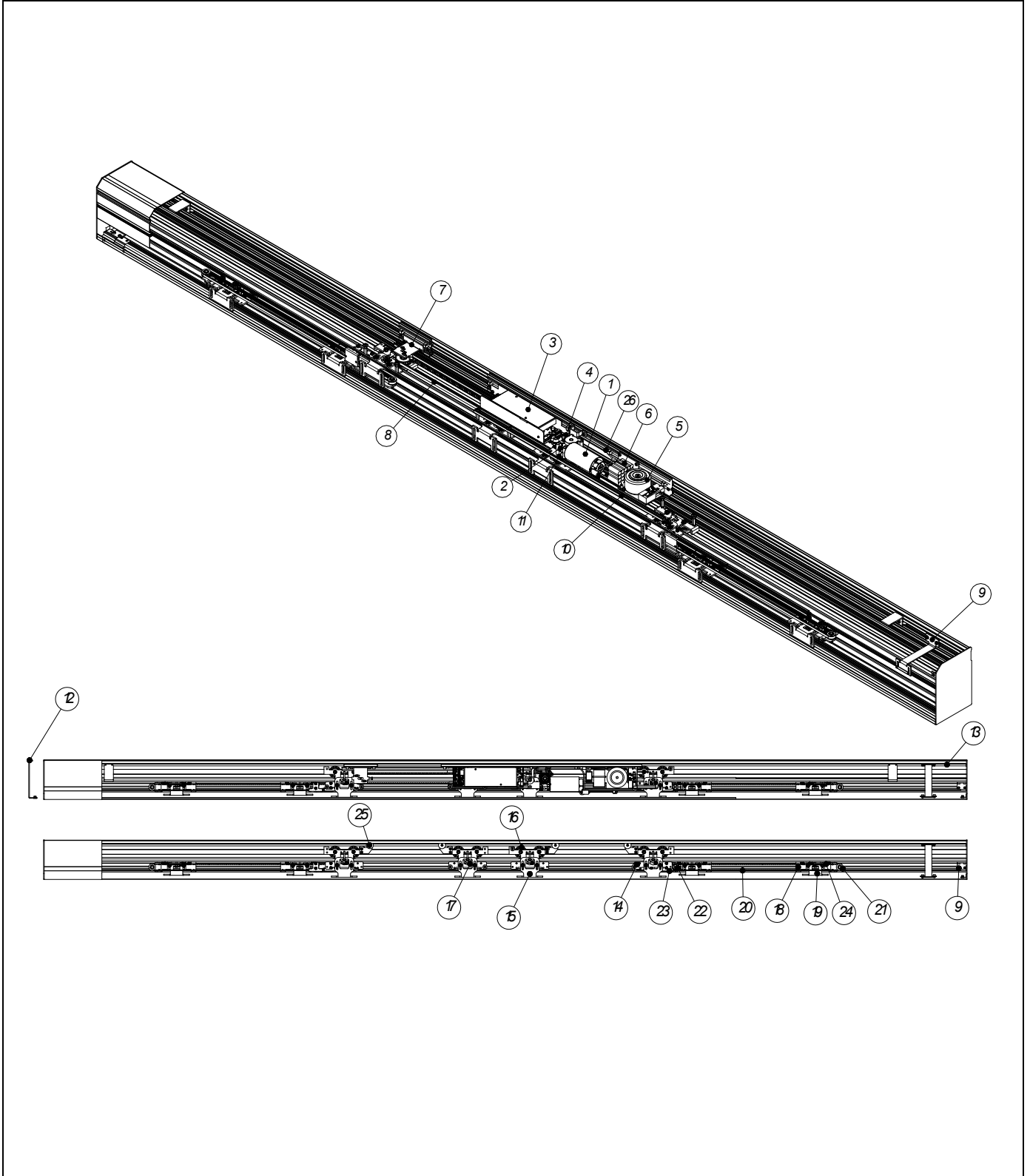

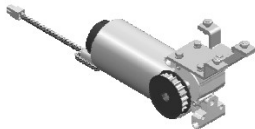







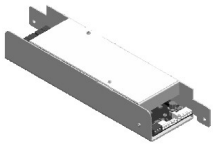

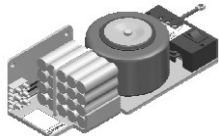

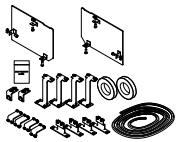
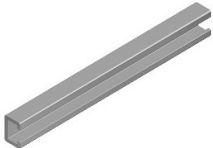

**OPERADORES  
TELESCÓPICO 4**





**OPERADORES  
 TELESCOPIC 4**

Nº	Ilustración	Artículo	Código
1		MOTORREDUCTOR GLOBAL 4	SUN41
2		POLEA MOTRIZ G4	SUN42
3		CUADRO ELECTRÓNICO E4 / G4 / T4	SER52
4		CABLEADO ALIMENTACIÓN PLACA ELECTRÓNICA E4 G4	SER54
5		SUBCONJUNTO FUENTE ALIMENTACIÓN 40V E4/G4	SER55
		SUBCONJUNTO FUENTE ALIMENTACIÓN 40V-125V E4/G4	SER56
6		PACK BATERÍAS NI Cd	SER57
7		SUBCONJUNTO REENVÍO GLOBAL_4	SUN43
8		CORREA HTD 8M 10MM (8 METROS)	SER59
9		TEL CLOSING	TEL CLOSING
10		PERFIL BRAZO L=850MM PERFIL BRAZO L=1050MM PERFIL BRAZO L=500MM	SUN09 SUN10

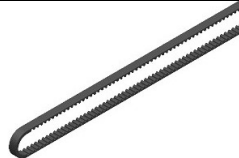
**OPERADORES  
 TELESCOPIC 4**

11		BOLSA CARRIER ERTAIN_2 / GLOBAL	SUN05
12		SOPORTE CENTRAL PARA TAPA TELESCOPIC	SOPORTE TAPA TEL
13		FINAL DE CARRERA ERTAIN SYSTEM	SER05
14		CARRO EXTERIOR TELESCOPIC SYSTEM	STE02
15		BRIDA DE ATAQUE EXTERIOR TELESCOPIC SYSTEM	STE04
16		ROLDANA ERTAIN SYSTEM <i>"Diámetro exterior = 52mm"</i>	SER16
17		ANTIDESCARRILAMIENTO ERTAIN SYSTEM	SER17
18		CARRO INTERIOR TELESCOPIC SYSTEM	STE01
19		BRIDA ATAQUE INTERIOR TELESCOPIC SYSTEM	STE03
20		CORREA HTD 5M 9 MM, -+0,5	STE05

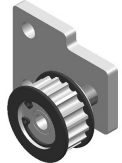
**OPERADORES  
 TELESCOPIC 4**

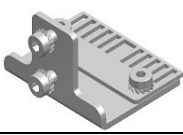
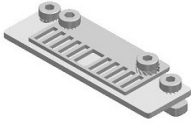
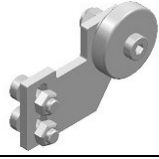
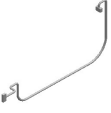
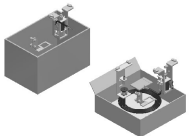
21		POLEA FIJA TELESCOPIC SYSTEM	STE06
22		POLEA MÓVIL TELESCOPIC SYSTEM	STE07
23		FIJACIÓN MÓVIL CORREA 5M	STE08
24		FIJACIÓN FIJA CORREA 5M	STE09
25		ERTAIN CUERNO	ERTAIN CUERNO
26		CABLEADO ENCODER MOTORREDUCTOR E4 G4	SER61
*		ELECTROBLOQUEO FAILSAFE E4 G4 ELECTROBLOQUEO FAILSECURE E4 G4	E4 FAILSAFE E4 FAILSECURE