

This quick guide is a summary of the complete installation guide. The guide contains safety warnings and other explanations that must be taken into account. The most recent versions of this guide and the installation manual are available in the "Downloads" section on Erreka's website.  
<http://www.erreka-automation.com>

**IMPORTANT NOTE**

The options and functions described in this guide apply for the firmware version indicated on the circuit. The firmware, as part of a process of continuous improvement, is subject to new functionalities or upgrades being included as a result of new versions which are not necessarily compatible with previous ones. For this reason, some options or functions may differ or be unavailable if your firmware is older than shown in this guide.

### Elements of the complete installation

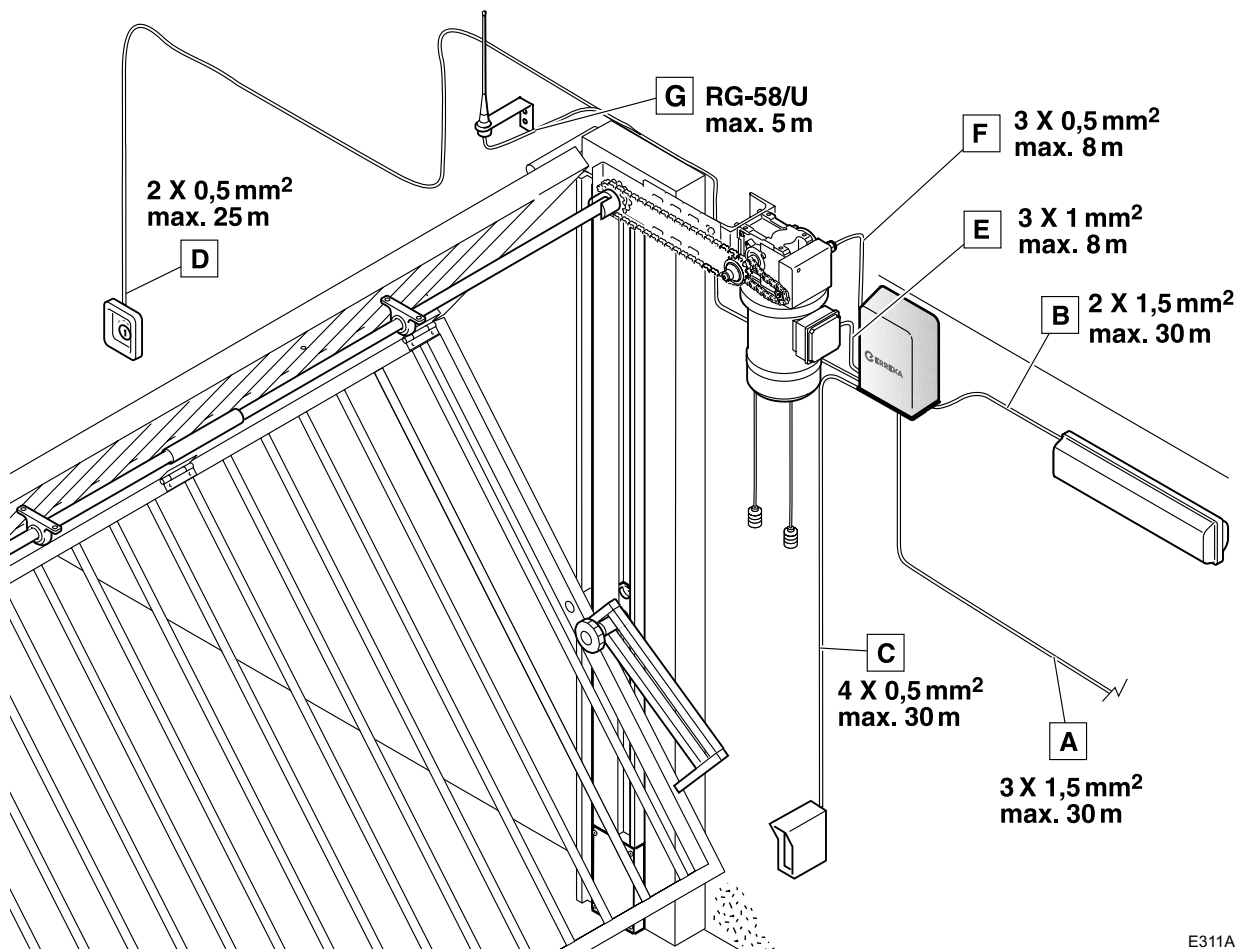

E311A

**ELECTRICAL WIRING:**

| Element                        | N° wires per section                       | Maximum length |
|--------------------------------|--|----------------|
| A: Main power supply           | 3x1.5mm <sup>2</sup>                       | 30m            |
| B: Garage light                | 2x1.5mm <sup>2</sup>                       | 30m            |
| C: Photocell                   | 4x0.5 mm <sup>2</sup>                      | 30m            |
| D: Pushbutton/wall key         | 2x0.5 mm <sup>2</sup>                      | 25m            |
| E/F: Operator / Limit switches | 3x1mm <sup>2</sup> / 3x0.50mm <sup>2</sup> | 8m             |
| G: Antenna                     | Coaxial cable 50Ω (RG-58/U)                | 5m             |

## General connections

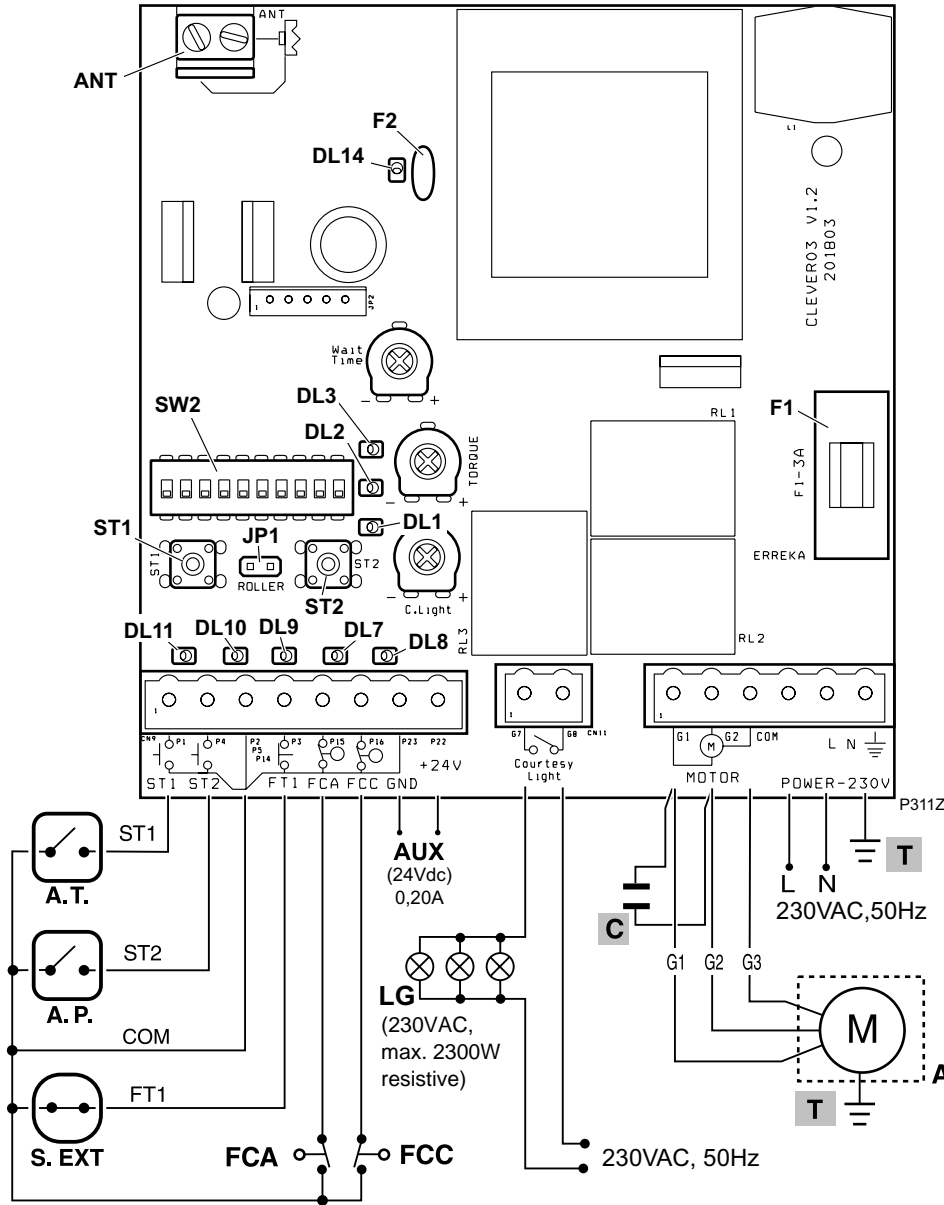

- DL1** (static): door fully or partially open (or on standby)
  - DL1** (flashing slowly): programming error
  - DL2** (static): radio programming
  - DL2** (flashing 0.5s): receiving radio code
  - DL3** Programming mode enabled (programming operation or radio code)
  - DL7** FCA contacts closed
  - DL8** FCC contacts closed
  - DL9** Safety device contacts (FT1) closed
  - DL10** Key command ST2
  - DL11** Key command ST1
  - DL14** Resettable fuse LED F2  
DL14 lit up: fuse closed;  
DL14 off: fuse open
- F1** Motor fuse M, 3A (5x20)  
**F2** Resettable secondary fuse (300mA) (resets automatically when overload finishes)

### Operator connections A:

- G1** open
- G2** close
- G3** common
- T** earth connection

- ANT** Antenna cable connectors
- SW2** DIPs for programming
- JP1** Radio receiver configuration:
  - JP1=ON (bridge): Roller Code
  - JP1=OFF (open): Fixed Code
- A.T.** Opening or total opening pushbutton (configurable via DIP5)
- A.P.** Closing or pedestrian opening pushbutton (configurable via DIP5)
- S.EXT** Safety device (photocell, etc.)
- FCA** Opening limit switch
- FCC** Closing limit switch
- AUX** 24VDC output to supply peripherals
- LG** Garage light (maximum 2300W resistive)
- ST1** Opening or total opening mini-pushbutton (configurable via DIP5)
- ST2** Closing or pedestrian opening mini-pushbutton (configurable via DIP5)

**Turning direction:** place DIP1 in ON and check operation using mini-pushbuttons ST1 (OPEN) and ST2 (CLOSE). If the turning direction of the operator is not correct, interchange the cables connected in cable connectors G1 and G2.

## SW2 functions during programming (DIP1 = ON)

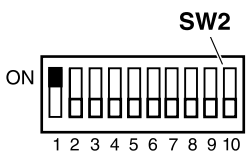

E311L

- DIP1=ON: programming enabled (DL3 lights up)
- DIP1=ON and DIP2=ON: total open/close programming
- DIP1=ON and DIP3=ON: pedestrian open/close programming
- DIP1=ON and DIP4=ON: total opening radio code programming
- DIP1=ON and DIP6=ON: pedestrian opening radio code programming

### Personalising the Roller transmitter code (JP1=ON)

If the receiver memory is empty and has default standard code (not personalised), place DIP1=ON and DIP4=ON and bridge between pins 1 and 5 of the 5-way connector of a personalised transmitter: the installer-installation code for this personalised transmitter is stored.

## Total opening radio code programming

☞ Ensure JP1 is configured correctly before starting:

- JP1=ON (bridge): Roller Code
- JP1=OFF (open): Fixed Code

**1** Place DIP1 in ON and close the leaf, holding down ST2.

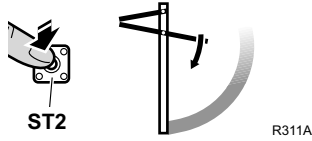

**2** When using fixed code transmitters, select the code in the transmitter.

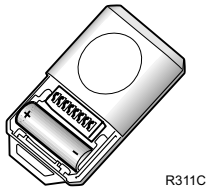

**3** Place the DIPs as shown in the figure (DIP1=ON, DIP4=ON). DL3 and DL2 light up to show programming mode enabled.

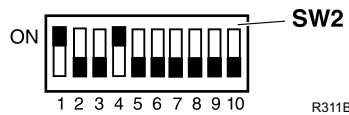

**4** Press the button for the required channel. DL2 flashes twice when programming is complete.



DL2 flashes 6 times if the memory is full.

**5** Place DIP1 and DIP4 in OFF. DL3 and DL2 remain off.

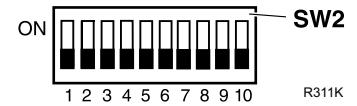

**6** Disconnect and reconnect the electrical power supply.

**Programming Roller transmitters via programmed Roller transmitter:** with the door closed, bridge between cable connectors 1 and 5 of the programmed transmitter: DL3 and DL2 light up for 10 seconds. Press the button for the transmitter to be programmed: DL2 flashes twice and the programming process ends.

### Pedestrian opening code

Programming is carried out in the same way, using DIP6 instead of DIP4.

With Roller transmitters, the button which will enable pedestrian opening is stored. This button is assigned to all transmitters stored for total opening.

## Deleting total opening radio code

(all the stored codes are deleted, independently of JP1 being selected)

**1** Place DIP1 in ON and DIP4 in ON.

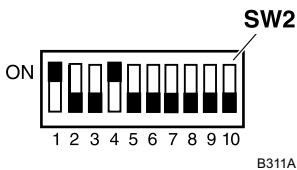

**2** Keep ST1 and ST2 held down at the same time for 5 seconds, until DL1, DL2 and DL3 flash quickly.

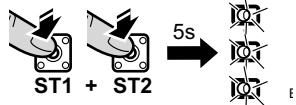

**3** Release ST1 and ST2.

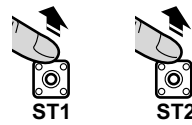

**4** Hold ST1 down for 5 seconds to confirm.



## Pedestrian opening radio code

It can be deleted in the same way by using DIP6 instead of DIP4, and ST2 instead of ST1 in the final step.

## Total open/close programming

**1** Select the type of door using DIP9 (sliding or up-and-over).

**2** Place DIP1 in ON and close the leaf, holding down ST2.

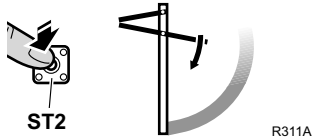

**3** Place DIP1 in ON, DIP2 in ON, DIP5 in OFF, DIP8 in ON (if using slowdown).



DL3 lights up (programming enabled).

**4** Press ST1 to start opening the leaf.

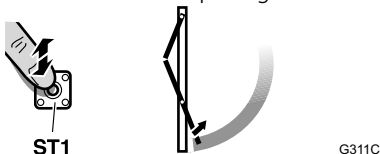

**5** Press ST1 to start slowdown (with DIP8=ON only).

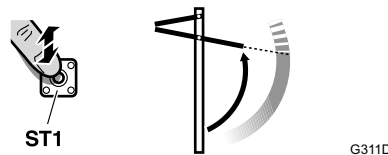

**6** Press ST1 to finish opening (pressing ST1 is not necessary if FCA is installed).

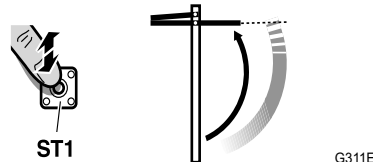

**7** Press ST1 to start closing the leaf.

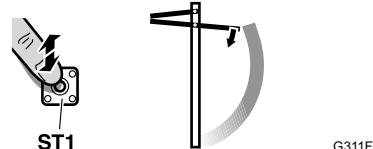

**8** Press ST1 to start slowdown (with DIP8=ON only).

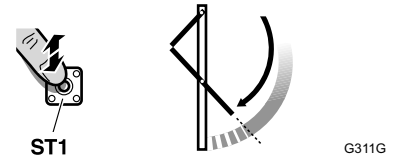

**9** Press ST1 to finish closing (pressing ST1 is not necessary if FCC is installed).

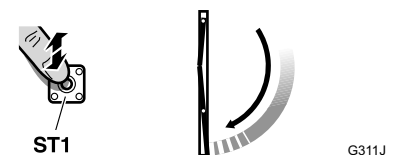

**10** Place DIP1 and DIP2 in OFF. DL3 remains off.



**i** **Photocell shade function in up-and-over door (DIP9=OFF):** when the photocell shadow function is enabled, the photocell is invalidated in the last part of the closing run. To do this, the control panel detects the position in which the leaf enables the photocell while programming the closing run, and takes it as a reference for invalidation during operations (invalidation comes about a moment before the point detected during programming).

## Pedestrian open/close programming

This is carried out in the same way as total open/close programming, with the following differences:

- DIP1 and DIP3 are used instead of DIP1 and DIP2
- ST2 is used instead of ST1 (except in step 1)

## Function and mode selection using SW2 (DIP1 = OFF)

| DIP   | Modes and functions   | Option | Effect   |
|-------|---|--------|--|
| DIP1  | Programming mode  | ON     | Programming mode enabled. The door can also be opened or closed by holding down ST1 or ST2 (in order to check turning direction, position the door, etc.).   |
|       |   | OFF    | Operating mode (programming disabled)  |
| DIP2  | Without use   | OFF    | Always place in OFF  |
| DIP3  | Opening mode  | ON     | <b>alternative stop</b> (the door stops if a key command is enabled during opening, and closes if enabled again)   |
|       |   | OFF    | <b>collective opening</b> (the control board does not obey the key commands during opening)  |
| DIP4  | Automatic or step-by-step mode (for pedestrian and total operation) | ON     | <b>automatic mode</b> (the door closes automatically after standby time has passed, which is adjusted using T.E.). Standby time restarts if the photocell is enabled   |
|       |   | OFF    | <b>step-by-step mode</b> (the door only closes when receiving the key command)   |
| DIP5  | ST1 and ST2 functions (A.T. and A.P.)                               | ON     | ST1: opening; ST2: closing (PAC)   |
|       |   | OFF    | ST1: total operation; ST2: pedestrian operation  |
| DIP6  | Automatic mode optional (only if DIP4 = ON)                         | ON     | during standby, the door obeys the key commands (can be closed before standby time finishes)   |
|       |   | OFF    | the door cannot be closed until standby time finishes; a key command will cause standby time to restart  |
| DIP7  | Braking due to reverse  | ON     | braking due to reverse enabled   |
|       |   | OFF    | braking due to reverse disabled  |
| DIP8  | Slowdown  | ON     | slowdown enabled in opening and closing: the leaves reduce their speed before reaching the stopper   |
|       |   | OFF    | no slowdown: the leaves reach the stopper at high speed  |
| DIP9  | Door type selection   | ON     | sliding door   |
|       |   | OFF    | up-and-over door with shadow function  |
| DIP10 | Dead-man mode<br>Only with DIP4=OFF                                 | ON     | <ul style="list-style-type: none"> <li>• with DIP5=ON: <b>dead-man mode in closing (HPC)</b>; the door is opened by briefly holding down ST1, and closed by holding down ST2</li> <li>• with DIP5=OFF: <b>dead-man mode in opening and closing (HPAC)</b>; the door is opened by holding down ST1, and closed by holding down ST2</li> </ul> |
|       |   | OFF    | Dead man function disabled   |

## Potentiometer adjustment

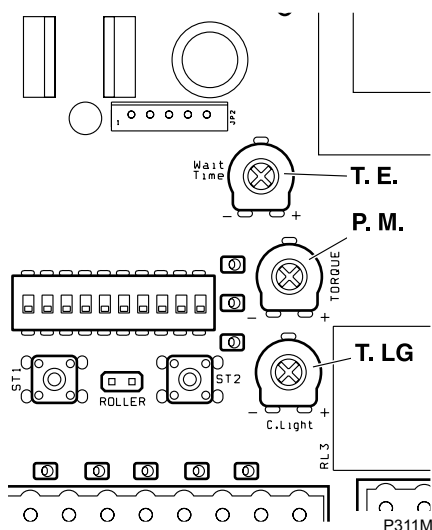

**T.LG. (garage light time):** if the garage lighting circuit has been connected to the control panel, regulate the time which the lights remain on using T.LG.

**T.E. (door open standby time):** if automatic functioning mode has been programmed (DIP4=ON), set T.E. to adjust standby time with the door open (before automatic closing begins).

**P.M (motor torque):** use P.M. to adjust the operator's maximum power value.

- Hydraulic operators: set P.M. at the maximum value.
- Electromechanical operators (anti-crushing function sensitivity): set P.M at the minimum value possible, compatible with the proper operation of the door.

**▲ Torque adjustment, respecting the maximum closing forces set out in Standard EN12453:2000. Make the measurements as described in Standard EN 12445:2000.**